

# DroneBeacon - Transponder Manual

## 122fpv-series

*February 2024 - version 1.3*

Remote ID for drones

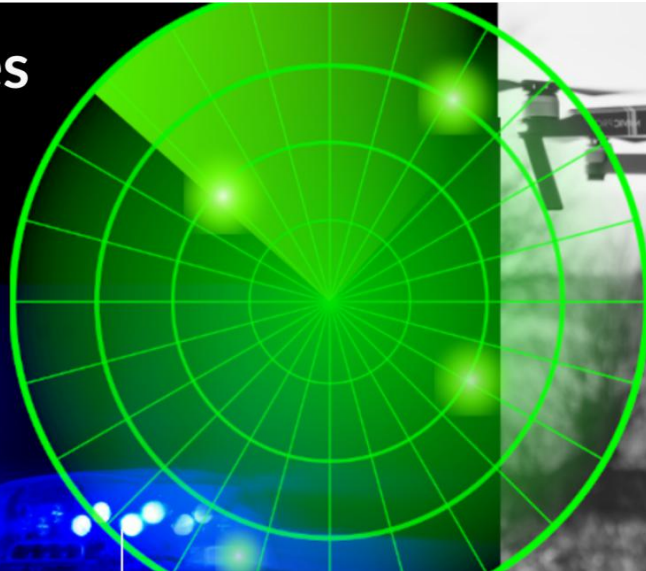

The latest version of this manual is located here:  
<https://download.bluemark.io/db122fpv.pdf>

**Intended audience:** users of the db122fpv transponder

**Disclaimer:** we are not responsible or liable for errors or incomplete information in this document.

### *Version history*

version	date	description
1.0	February 2023	● Initial release
1.1	April 2023	● Updated documentation prior to public release
1.2	November 2023	● Added EU information
1.3	February 2024	● Updated documentation with latest firmware, support for UBX protocol



# QUICK START

## Attach to the drone



- Attach the DroneBeacon db122fpv board to your drone by installing it between the GNSS (GPS) receiver and your flight controller.
  - Connect the BN-880 or other GNSS receiver that supports the NMEA GPS protocol to the *GPS IN* port using the provided Molex PicoBlade cable.
    - ◆ In case you use a different GNSS receiver, make sure the pin-layout and connector type matches the pin-layout/connector of the *GPS IN* port. If not, use a converter cable. **Wiring, see section 1.4.**
  - Connect the *GPS OUT* port db122fpv board to the flight controller using a Molex PicoBlade cable. Make sure the pin-layout of both connectors are similar.

## Use the db122fpv

- If you power on the drone, the db122fpv will be automatically powered on too.
- Wait for a GPS fix (slowly flashing status LED every 4 seconds). You are ready to fly.

## Status LED

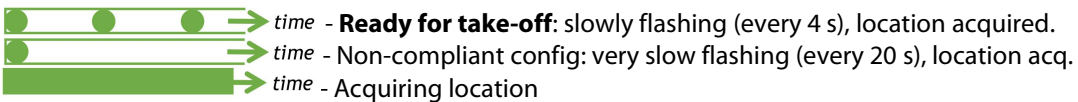

## Configuration

For typical use in the USA no configuration is required. USA: use the db122fpv S/N number for registering your drone at the [FAA](https://www.faa.gov). For the EU, you need to enter your operator ID and UA class.

- After the db122fpv is powered, press the configuration button. The *red* config LED is now solid red.
- Connect to the *dronebeacon* WLAN network (no password needed)
- Point your browser to <http://192.168.50.1> or scan the QR code.



*Flying a drone could create risks for people, air traffic and other assets. Before flying, the drone operator has to make sure to know the local rules regarding drone flights and obtain the necessary authorization to fly the drone(s).*



configuration web-page

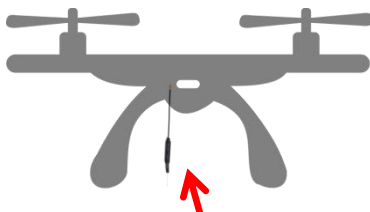

*db122fpv Vertical antenna installation. Thick antenna part should not be obstructed by metal objects*

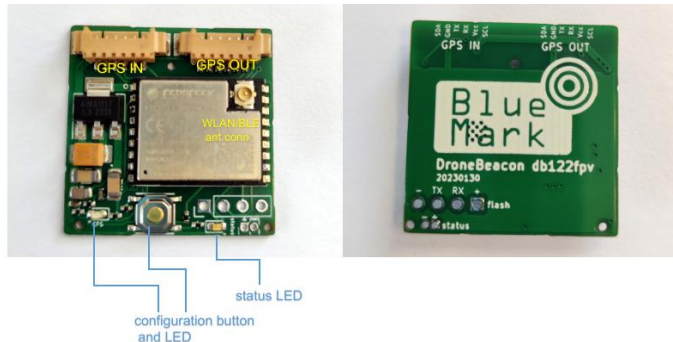

# Contents

Quick start .....	3
1 Introduction .....	5
1.1 Audience .....	5
1.2 Specifications .....	5
1.3 What's in the Box .....	7
1.4 Installation .....	7
1.5 Using the transponder .....	8
1.6 EMC test .....	9
1.7 Android/iOS app .....	9
1.8 Open Drone ID .....	9
2 Configuration .....	10
2.1 UART .....	10
2.2 General .....	11
2.3 Operator .....	12
2.4 Flight .....	13
2.5 Radio .....	14
2.6 Firmware .....	15
3 Current profile .....	17
4 Troubleshooting .....	18
5 Warranty .....	19
6 More information .....	20



# 1 INTRODUCTION

Thank you for purchasing and using DroneBeacon products!

The latest version of this user manual may be downloaded at the following link:

<https://download.bluemark.io/db122fpv.pdf>

(Direct/Broadcast) Remote Identification (Remote ID) adds “beacon” capability to drones to broadcast basic information of airborne drones, such as the operator’s registration number, drone serial number and current position. The EU and USA have new rules that make Remote ID mandatory for drones over 250 grams weight. The beacon information can be used by general public, law enforcement and drones to give better situation awareness of the airspace around them.

BlueMark Innovations BV offers Remote ID transponders and receivers. DroneBeacon db122fpv is an add-on (transponder) for drones that broadcasts Remote ID beacon signals. The module is designed for FPV drones and a BN-880 GPS receiver, but of course it can be used for other drones as well. Besides the db122fpv we also provide other Remote ID add-ons. DroneScout is a receiver that detects Remote ID signals of nearby drones up to several km distance (in open space). See <https://dronescout.co> for more information about our products.

## 1.1 Audience

This document is intended for users that want to use the *DroneBeacon db122fpv* transponder as a stand-alone Remote ID add-on for their FPV drone or other UAV product. There is a separate manual for the *DroneBeacon MAVLink db201* transponder (intended for drone manufacturers). Also we provide a stand-alone Remote ID add-on with battery: the db120 transponder and without: db121/db121pcb.

## 1.2 Specifications

The transponder consists of an embedded system and several radio-interfaces to broadcast Remote ID signals.

In the EU, the db122fpv is a *Direct remote identification (DRI) Add-on*. DRI Add-ons are considered as payload in the EU. DRI means a system that ensures the local broadcast of information about a Unmanned Aircraft (UA) in operation, including the marking of the UA, so that this information can be obtained without physical access to the UA. A DRI Add-on is standalone direct remote ID broadcast device integrating a GNSS function and a communication. function, being able to provide position, height, speed over ground, track clockwise with true north, of the UA, and it’s take-off position. In the USA, the db122fpv is a *Remote ID broadcast module*.



## Regulation

The db122fpv transponder complies and adheres to the following regulations:

region		
EU	DELEGATED REGULATION (EU) 2019/945 PART 6	March 2019
	DELEGATED REGULATION (EU) 2020/1058	April 2020
	ASD-STAN FprEN-4709-002:2023 (E) (Part 002: Direct Remote Identification)	June 2023
USA	ASTM, International (ASTM) F3586-22, with additions	July 2022

The EU Declaration of Conformity can be found here:

[https://dronescout.co/wp-content/uploads/2023/09/EU-DoC\\_standalone.pdf](https://dronescout.co/wp-content/uploads/2023/09/EU-DoC_standalone.pdf)

Key specifications:

- **Compliant with international regulations**
  - EU ASD-STAN DIN EN 4709-002
  - USA ASTM Remote ID Standard ASTM F3411-22a-RID-B/ F3586-22
    - ◆ Accepted by the FAA
      - db122fpv <https://uasdoc.faa.gov/listDocs/RID000000175>
- Supports **all Remote ID transmission protocols**:
  - BLE legacy
  - BLE long range
  - WLAN NaN 2.4 GHz
  - WLAN Beacon 2.4 GHz
- **Long range** up to 5 km detection range<sup>1</sup>
  - Omni-directional antenna with 3 dBi gain.
  - Transmit power: +18 dBm (WLAN and Bluetooth)
- Power by the GPS out connector
  - Input voltage range: 4.5 to 15 V
  - 6-pin Molex PicoBlade connector
- GPS connectors
  - 2x 6-pin Molex PicoBlade connectors: *GPS IN* and *GPS OUT*: SDA, GND, TX, RX, Vcc, SCL
- GPS protocol
  - NMEA or UBX (u-blox, firmware 20240208-1759 and higher )
- For operation in rainy conditions, the transponder needs to be protected against water.
- Dimensions (l x w x h):
  - db122fpv: 28 x 28 x 4 mm.
- Operating temperature
  - -5°C to +40°C
- Weight:
  - 4 g (db122fpv, including antenna, excluding other cables)



<sup>1</sup> The detection range depends on several factors such as the receiver antenna gain, transmission protocol, weather conditions, flying height, receiver height line of sight etc. With professional receivers a range up to 5 km is possible.



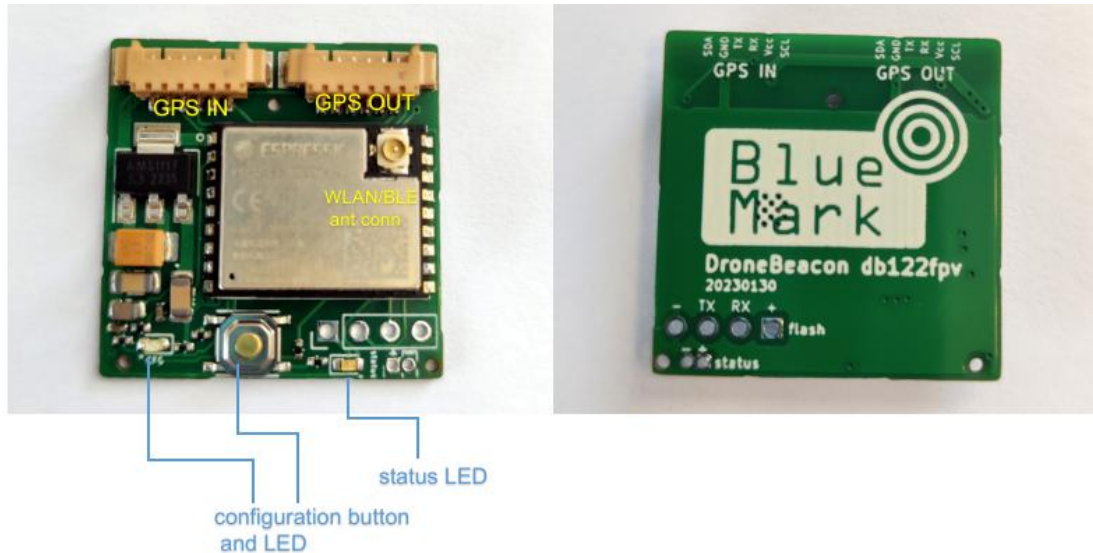

Figure 1 - DroneBeacon db122fpv transponders

## 1.3 What's in the Box

The following package contents should be present:

- 1x db122fpv transponder including external IPEX/u.FL WLAN/Bluetooth antenna
- 1x Molex PicoBlade cable ~ 4 cm
- 2x 3M Double-Sided 3M 15 mm Round Self Adhesive Sticker (1 extra)
- sticker with valid FAA serial number (programmed in the module, but also provided as sticker.)

## 1.4 Installation

### cables

- Connect the BN-880 or other GNSS receiver that supports the NMEA (or UBX) GPS protocol to the *GPS IN* port using the provided Molex PicoBlade cable.
  - In case you use a different GNSS receiver, make sure the pin-layout and connector type matches the pin-layout/connector of the *GPS IN* port. If not, use a converter cable.
- Connect the *GPS OUT* port db122fpv board to the flight controller using a Molex PicoBlade cable. Make sure the pin-layout of both connectors are similar.

The flight controller will power both the db122fpv and also the attached GNSS receiver.

*Note: the pin description of the GPS IN port describes the pins of the attached GNSS receiver. Hence the RX port of the GPS IN port is used by the module to transmit information to the RX port of the attached GNSS receiver. So you can use for both the GPS IN and OUT ports the same cables as you would use to connect the GNSS receiver to the flight controller. See also Figure 2.*



Connect Vcc to Vcc, GND to GND, Connect TX of the flight controller to RX of GPS out and RX to TX of GPS OUT. Similar wiring as to a normal GNSS receiver

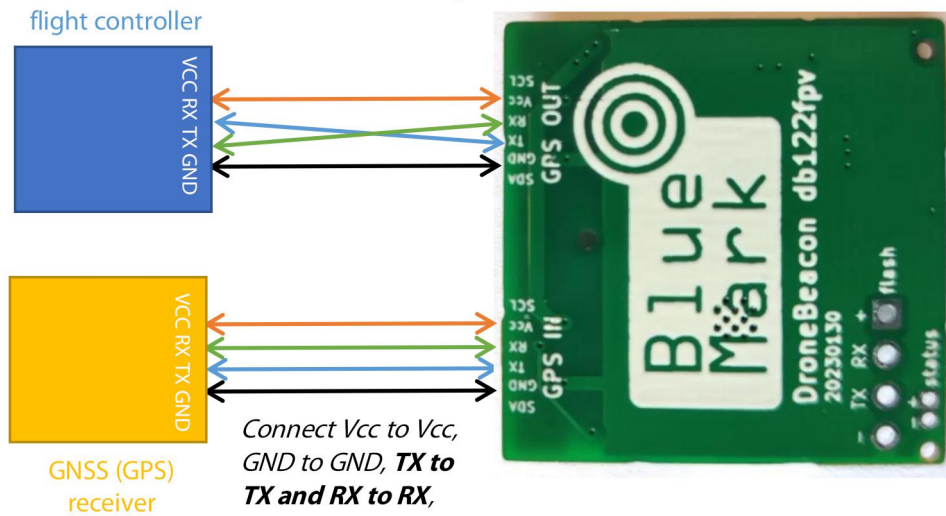

Figure 2 - Wiring of the db122fpv transponders to the GNSS receiver and flight controller

### GNSS configuration

The db122fpv reads the GPS signals of the GNSS receiver attached to GPN in port. This information is used for Remote ID signals. The received GPS signals also relayed to the GPS OUT port. Chapter 2 (section 2.1) describes how you can configure the UART settings of the *GPS IN/OUT* port.

### status led

The status led should be visible by the user. And the user can only take-off if the status LED signals ready to take-off. **If the status LED is not visible, it will void the FAA DoC status of the db122fpv product!**

## 1.5 Using the transponder

- Wait for the status LED to signal ready for take off/GPS fix (slowly flashing battery LEDs every 4 seconds).
- You are ready to fly.

### Status LED

The status LED can have the following states:

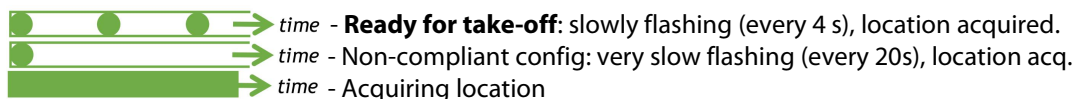

Note:

- For typical use in the USA no configuration is required. USA: use the db122fpv S/N number for registering your drone at the [FAA](#).
- For the EU, you need to enter your operator ID and UA class.
- A non-compliant configuration can be caused by selecting a non-compliant transmission protocol, selecting a lower transmit power (for WLAN modes) or selecting a different channel for WLAN modes than the default channel 6.







*Flying a drone could create risks for people, air traffic and other assets. Before flying, the drone operator has to make sure to know the local rules regarding drone flights and obtain the necessary authorization to fly the drone(s).*

## 1.6 EMC test

To verify that the db122fpv does not produce interference to the drone or receives interference from the drone, it is advised to do a quick EMC test. (Only when attached for the first time to a drone.)

- Power on the drone and remote control. Keep the db122fpv powered off.
- Verify that the drone, remote control and wireless link are functioning properly.
- Power off the drone and remote control.
- Power on the db122fpv (using a different power source). Keep the drone and remote control powered off.
- Verify that the db122fpv is functioning properly. For instance by using the Android in Section 1.7 or by looking at the status LED (ready for take-off state).
- Repeat the tests by powering on both the db122fpv, the drone and remote control. If both the db122fpv and drone, remote control and wireless link are functioning properly, there is no EMC interference between both systems.
- In case there is interference, please move the db122fpv to a different place on the drone and repeat the tests. Alternatively lower the output power or change the transmission protocol.

## 1.7 Android/iOS app

You can use the free *OpenDroneID OSM* Android app to view the DroneBeacon Remote ID signals: [https://play.google.com/store/apps/details?id=org.opendroneid.android\\_osm](https://play.google.com/store/apps/details?id=org.opendroneid.android_osm)

Or the Drone Scanner Android app:

<https://play.google.com/store/apps/details?id=cz.dronetag.dronescanner>

Note: only few Android smartphones support reception of Bluetooth Long Range and/or WLAN NaN signals. Also, in default Android configuration, WLAN Beacon signals are typically received only once every few minutes. A list of supported smartphones is presented, in the link below.

<https://github.com/opendroneid/receiver-android/blob/master/supported-smartphones.md>

### iOS

The Drone Scanner app is also available for iOS. Due to limitation of iOS only BT4 reception is possible.

<https://apps.apple.com/gb/app/drone-scanner/id1644548782>

## 1.8 Open Drone ID

DroneBeacon uses the Open Drone ID framework to broadcast Remote ID signals. The framework can be found on this page: <https://www.opendroneid.org/>



## 2 CONFIGURATION

The transponder can be configured via a web-interface. To active the configuration mode follow these steps:

- Power on the db122fpv transponder board.
- Press the configuration button, the *red* configuration LED is turned on.
- Connect to the *dronebeacon* WLAN network (no password needed)
- Point your browser to <http://192.168.50.1>

New settings will only be applied if the Save button is pressed!

Configuration mode will be quit, by pressing the configuration button again. The *red* configuration LED is now turned off. The transponder is now in normal operation mode.



*configuration web-page*

### 2.1 UART

On this page you can configure the UART settings for the GPS IN/OUT port. Here the baud rate , data bits, parity and stop bits of the *GPS IN/OUT* connectors are configured. Both ports will use the same UART settings. For most users the standard settings (auto baud rate detection) will work.

At the bottom of the page there is the GNSS status. It will show if the db122fpv module can receive NMEA messages. There are four different status codes:

- No GPS data, check UART settings!
- Partial GPS data, it needs GGA, GSA, RMC, GLL
- OK, GPS data received, no GPS fix
- OK, GPS data received and GPS fix (x)

**If you change the GNSS configuration, exit first the configuration mode and enter it again. Otherwise the GNSS status is not updated!**

**This will not work if the baud rate is set to AUTO.**

Notes:

- the GNSS receiver needs to provide NMEA GGA, GSA, RMC and GLL messages to the Remote ID module OR it receives UBX messages (UBX-NAV-PVT)
- the db122fpv will also forward UART messages received by the *GPS OUT* port to the *GPS IN* port.
- the status *No GPS data* indicates that the GNSS UART configuration is wrong. *If the db122fpv is set to baud rate detection (AUTO), the GNSS status will not be detected!*



# DroneBeacon configuration FPV

firmware: 20240208-1759

UART	General	Operator	Flight	Radio	Firmware
------	---------	----------	--------	-------	----------

Baud rate:   
Baud rate for communication with the GNSS (GPS) receiver.

Data bits:   
Data bits for communication with the GNSS (GPS) receiver.

Parity:   
Parity for communication with the GNSS (GPS) receiver.

Stop bits:   
Stop bits for communication with the GNSS (GPS) receiver.

GNSS status: **No GPS data, check UART settings!**  
If you change UART settings; save them and exit configuration mode to apply these new settings. Enter configuration mode again to check this status.

After pressing Save, press the configuration button again to exit this mode and return to normal mode.

Figure 3 - UART configuration page

## 2.2 General

The main configuration can be found on the general tab.



## DroneBeacon configuration FPV

firmware: 20240208-1759

UART
General
Operator
Flight
Radio
Firmware

Serial number:   
Serial number of the transponder.

UAS type:   
Set the type of the UAV. Use Helicopter or Multirotor for a typical drone.

**Auxillary ID**

Typically, consumers don't need to enter a second ID when they fly a drone. It is mostly relevant for companies operating UAVs in the EU. Set ID type to None to disable this second ID.

ID type:   
Set the type of the ID. Set to None to disable.

Auxillary ID:   
An auxillary ID. You can use it to enter the Serial Number of the UAV or enter your company number provided by the local aviation authorities. Note: for all ID types the input is considered as a string.

UAS type:   
Set the type of the UAV. Use Helicopter or Multirotor for a typical drone. Make sure it is set to the same UAS type as the type of the main Serial Number (top of this page).

Save
To factory defaults

After pressing Save, press the configuration button again to exit this mode and return to normal mode.

*Figure 4 - General configuration page*

Fill in the drone type. Normal users don't need to fill in an Auxillary ID.

## 2.3 Operator

In the operator tab, you can configure the details of your license provided by the National Aviation Authority. This is an optional setting for the USA. In the USA you need to use the serial number of the db120 instead for register your drone at the FAA. For the EU, this is a mandatory setting. *First, select the region where the drone is flying.* Outside the EU, no UAS category or UAS class is required.

Within the EU, only valid license numbers can be entered. In that case the input box becomes green.



# DroneBeacon configuration FPV

firmware: 20230414-1301

UART	General	<b>Operator</b>	Flight	Radio	Firmware
------	---------	-----------------	--------	-------	----------

Region:    
Set the region where the drone is flying.

Registration number:    
*Optional* identifier delivered by the National Aviation Authority after registering your UAS.

After pressing Save, press the configuration button again to exit this mode and return to normal mode.

# DroneBeacon configuration FPV

firmware: 20230414-1301

UART	General	<b>Operator</b>	Flight	Radio	Firmware
------	---------	-----------------	--------	-------	----------

Region:    
Set the region where the drone is flying.

Registration number:    
This identifier delivered by the National Aviation Authority after registering your UAS. Enter the full number like NLD87astrdge12k8-abc. It will check if the registration number is valid and will only store the public part. Invalid registration numbers won't be saved.

UAS category:    
The category is delivered by the National Aviation Authority after registering your UAS.

UAS class:    
The class is delivered by the National Aviation Authority after registering your UAS.

After pressing Save, press the configuration button again to exit this mode and return to normal mode.

Figure 5 - Operator configuration page

## 2.4 Flight

In the flight tab, you can configure an *optional*/text describing the purpose of your flight.



# DroneBeacon configuration FPV

firmware: 20230414-1301

UART	General	Operator	Flight	Radio	Firmware
------	---------	----------	--------	-------	----------

Description:

Enter an optional description (or purpose) for your flight (maximum 23 characters).

After pressing Save, press the configuration button again to exit this mode and return to normal mode.

Figure 6 - Flight configuration page

## 2.5 Radio

In the radio tab you can configure the transmission mode and other radio-related settings. Most users don't change settings in this section. Note that in the USA only BLE dual-mode and WLAN broadcast transmission mode are allowed. In the EU BLE legacy is optional transmission mode. One of the other transmission methods (BLE Long Range, WLAN NaN or WLAN Beacon) are mandatory. Of course, BLE dual-mode (default setting) is compliant too in the EU.



# DroneBeacon configuration FPV

firmware: 20240208-1759

UART	General	Operator	Flight	<b>Radio</b>	Firmware
------	---------	----------	--------	--------------	----------

**Advanced settings, most users don't change these settings.**

Transmission mode: BLE dual mode: legacy +   
Configure the transmission mode. For maximum compatibility, select BLE dual mode. Using a WLAN transmission mode will lower the battery life by roughly 50%.

Transmission period: 1 Hz (1s)   
Configure how often the transponder broadcasts its location. Most users keep this value at 1 Hz (1 s).

WLAN channel: 6   
Advanced setting: configure the channel for WLAN transmissions. Default is channel 6. Other channels will consume more power as more transmissions per seconds are required.

Broadcast device name:   
Advanced setting: if enabled, it will broadcast 'DroneBeacon ' and the last 4 characters of the serial number as BLE device name and as SSID (if those broadcast methods are enabled). In the EU this option needs to be enabled for WLAN broadcast methods in order to be compliant.

Reply to active WLAN scanning:   
Advanced setting: if enabled, it will reply to active WLAN scanning requests. This is an optional feature that is not mandatory in Remote ID. If disabled, it will be harder by smartphones to detect WLAN Remote ID signals. This setting only applies if the WLAN broadcast method is used.

Transmit power: +18 dBm   
Set the transmission power. Most users keep this value at +18 dBm. A lower value means that the detection range decreases. This setting is used both for BLE and WLAN transmission. Note: setting a lower transmission power than the maximum (+18 dBm) is non-compliant for WLAN modes. The battery life is extended up to 8% if +6 dBm is selected (compared to +18 dBm).

**After pressing Save, press the configuration button again to exit this mode and return to normal mode.**

Figure 7 - Radio configuration page

## 2.6 Firmware

In the firmware tab, you can upgrade the firmware of the transponder.

Firmware files can be found here: <https://dronescout.co/downloads/>

Upload the file and press Flash image to upload new firmware. Upgrading firmware has been tested with Chrome and Firefox. If upgrade fails, please try again or try another browser.



# DroneBeacon configuration FPV

firmware: 20230414-1301

UART	General	Operator	Flight	Radio	Firmware
------	---------	----------	--------	-------	----------

Firmware file:  No file chosen

Select the new firmware (with extension bin) and press the flash image button to upgrade. If flashing fails or you flash the wrong file, it will automatically fallback to the previous firmware version.

**After pressing the flash image button, the device will automatically reboot within 30 seconds. Press the cfg-button on the device again to check the running firmware.**

Figure 8 - Firmware upgrade page





### 3 CURRENT PROFILE

The current profile has been measured using a digital current meter with a  $\sim 7.2$  kHz sampling rate. Below the current profile (db122fpv) has been shown for 5 seconds (without attached GNSS receiver). Here, Bluetooth legacy and Bluetooth Long Range have been enabled. Also, the module transmits with maximum transmit power (+18 dBm). On the left the module is powered off and then connected to power (+5 V).

- The startup current profile is shown in the first 0.8 seconds.
- The *average* current is 42 mA ( $\sim 210$  mW).
- The *median* current -if there is no transmission- is 32 mA ( $\sim 160$  mW).
- The *peak* current is 280 mA<sup>2</sup> ( $\sim 1.4$  W).
- If the transmit power is reduced in the firmware, the peak current will also be smaller.

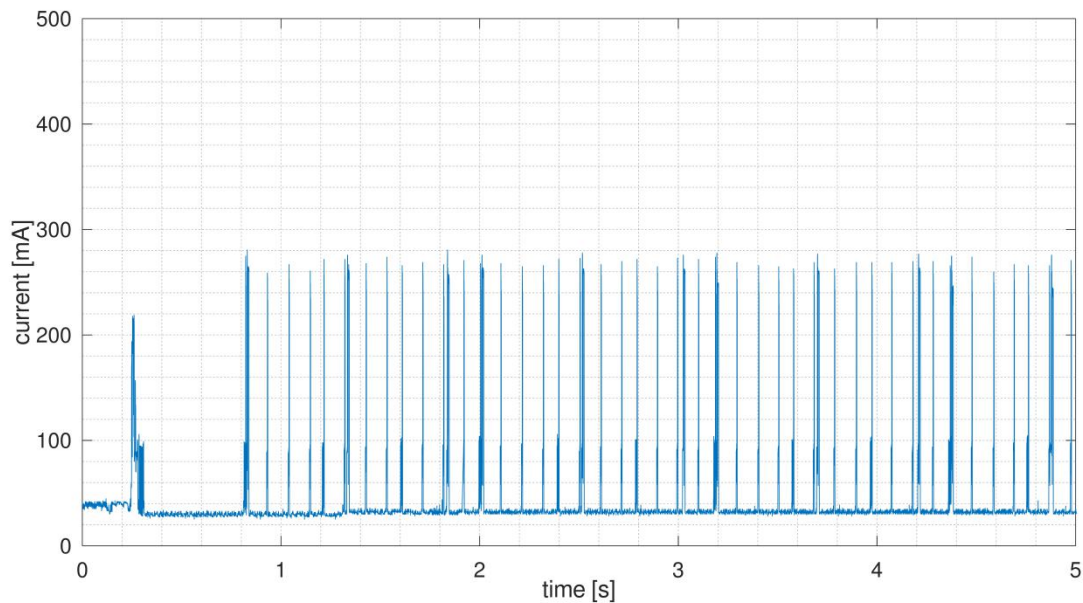

Figure 6 - Current profile of the db122fpv transponder with BLE legacy and BLE Long Range enabled (input voltage +5V)

---

<sup>2</sup> The maximum *instantaneous* current may be higher, as the maximum value is limited by the sample rate of the current meter.



## 4 TROUBLESHOOTING

### **Access to the configuration web-pages fails.**

Failing to access the configuration web-pages can have multiple causes. Make sure the configuration LED is solid red. Also, make sure that you connect to the *dronebeacon* network. If you get a message that the network does not provide internet, make sure you decline the message to disconnect and connect to your default WLAN network again. The browser *Safari* can also give issues to connect to the configuration web-pages. Use a different browser in this case. Also, a VPN, browser add-ons or another active internet connection can give issues. Disconnect the VPN and other internet connections. The easiest solution is use a different device to connect to the configuration pages.

### **The reported height is wrong.**

The db122fpv uses the GNSS (GPS) signal to determine the height of the db122fpv. It needs a good GPS reception/fix for this purpose. Make sure you install the external GPS module has good GPS reception.

### **The db122fpv interferes with the drone communication link.**

Move the db122fpv to a location further away from the drone communication antenna. Even 10 cm extra distance can make a huge difference. See also section 1.6 EMC test. In addition, change the transmission protocol if the interference persists. Typically, Bluetooth transmission protocols cause less interference to other radio systems. Also a lower the transmit power will reduce interference.

### **The red configuration LED glows softly when the db122fpv is powered on.**

If the power source is too weak, the db122fpv will not boot normally and will be stuck in the bootloader. Also if the configuration button is stuck (pressed) when the device boots, the db122fpv will not boot normally, but instead will enter a special boot mode. If this is the case the red configuration LED will glow softly. To solve this, make sure that that the configuration button is not pressed or is stuck.



## 5 WARRANTY

The product has a two-year warranty period, starting at the date of receiving the product. Outside warranty are issues like crash damage, improper use, (extreme) weather conditions that damages the product. Also, the battery is excluded from warranty. The product is eligible for future firmware updates as described in the section 2.4 firmware.

### **Warranty Service**

Please email or call us first with a description of the problem. Typically, the customer is responsible for transportation costs to our office. For post-warranty cases contact us too; we will try to do our best to find a solution.



## 6 MORE INFORMATION

If you need more information, please contact us at [info@bluemark.io](mailto:info@bluemark.io) or by phone: +31 53 711 2104.

All contact information can be found at the *DroneScout* contact page:  
<https://dronescout.co/contact/>

Postal address:

BlueMark Innovations BV  
Bruggenmorsweg 10  
7521ZV Enschede  
the Netherlands

